

DATA SHEET BST-02

BLADDER SURGE TANK

500psi

Nominal Size (Gallon)	Model Number	"A" APPR. OAH.(In.)	"B" Dia. (In.)	"C" Fluid Port Connector	Est. Dry Weight (Lbs.)	Design Pressure (psig.)
40	40BST-50	44.0	24	4"-300# RF ANSI	850	500
100	100BST-50	80.0	24	4"-300# RF ANSI	1160	500
150	150BST-50	104.0	24	4"-300# RF ANSI	2000	500
250	250BST-50	85.0	36	8"-300# RF ANSI	2631	500
500	500BST-50	95.0	48	8"-300# RF ANSI	3800	500

- ALL WETTED PARTS ARE STAINLESS STEEL OR EPOXY COATED CARBON STEEL.
- 500 PSI DESIGN PRESSURE WITH A 4X SAFETY FACTOR.
- ASME CODED, SECTION VIII, DIV. 1.
- BLADDER MATERIAL IS NITRILE RUBBER (BUNA-N).
- TOP REPAIRABLE DESIGN

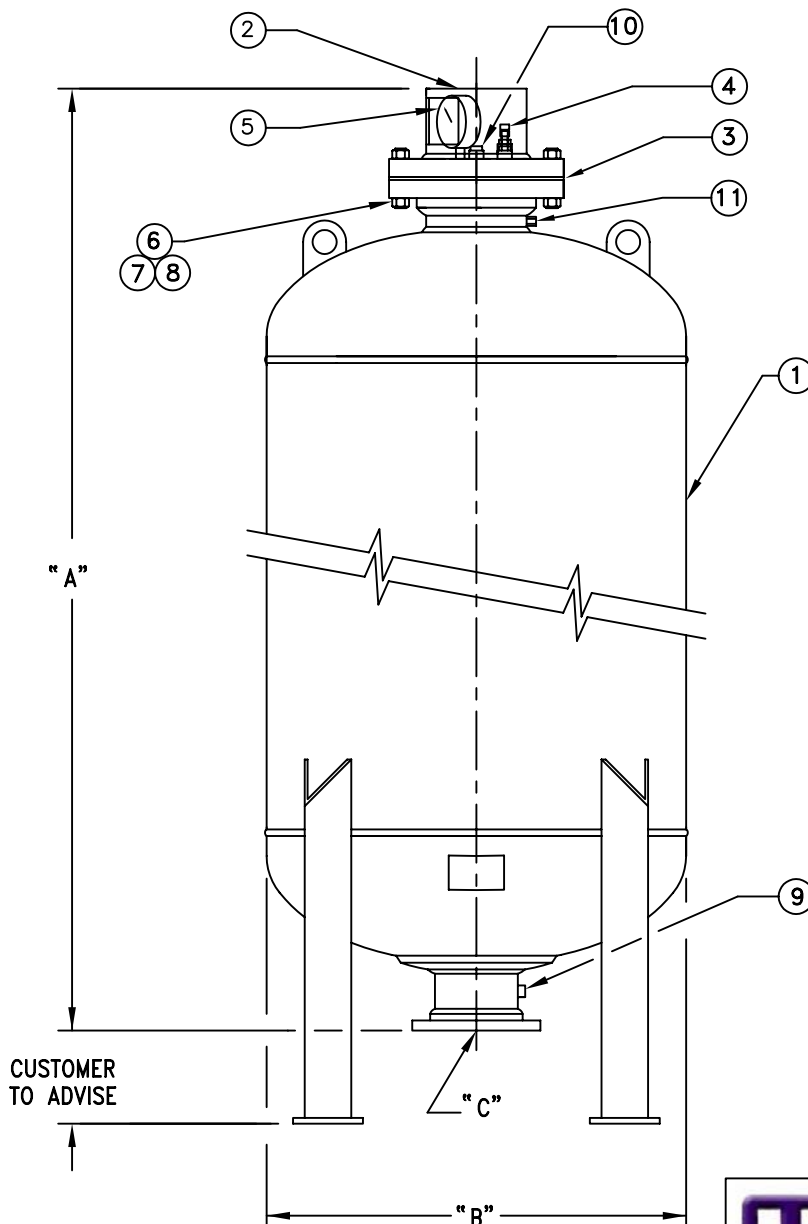

PARTS LIST:

Item	Description
1	SHELL ASS'Y
2	GAS PLATE ASSEMBLY
3*	BLADDER
4	GAS CHARGING VALVE
5	PRESSURE GAUGE
6	THREAD STUD
7	HEX. NUT
8	FLAT WASHER
9	1/2" SQ. PIPE PLUG
10*	1/2" RUPTURE DISC
11	1/4" NPT PIPE PLUG

*Recommended replacement parts.